

LEGO MINDSTORMS NXT 2.0

INSTRUKCJA BUDOWY CASTOR BOT

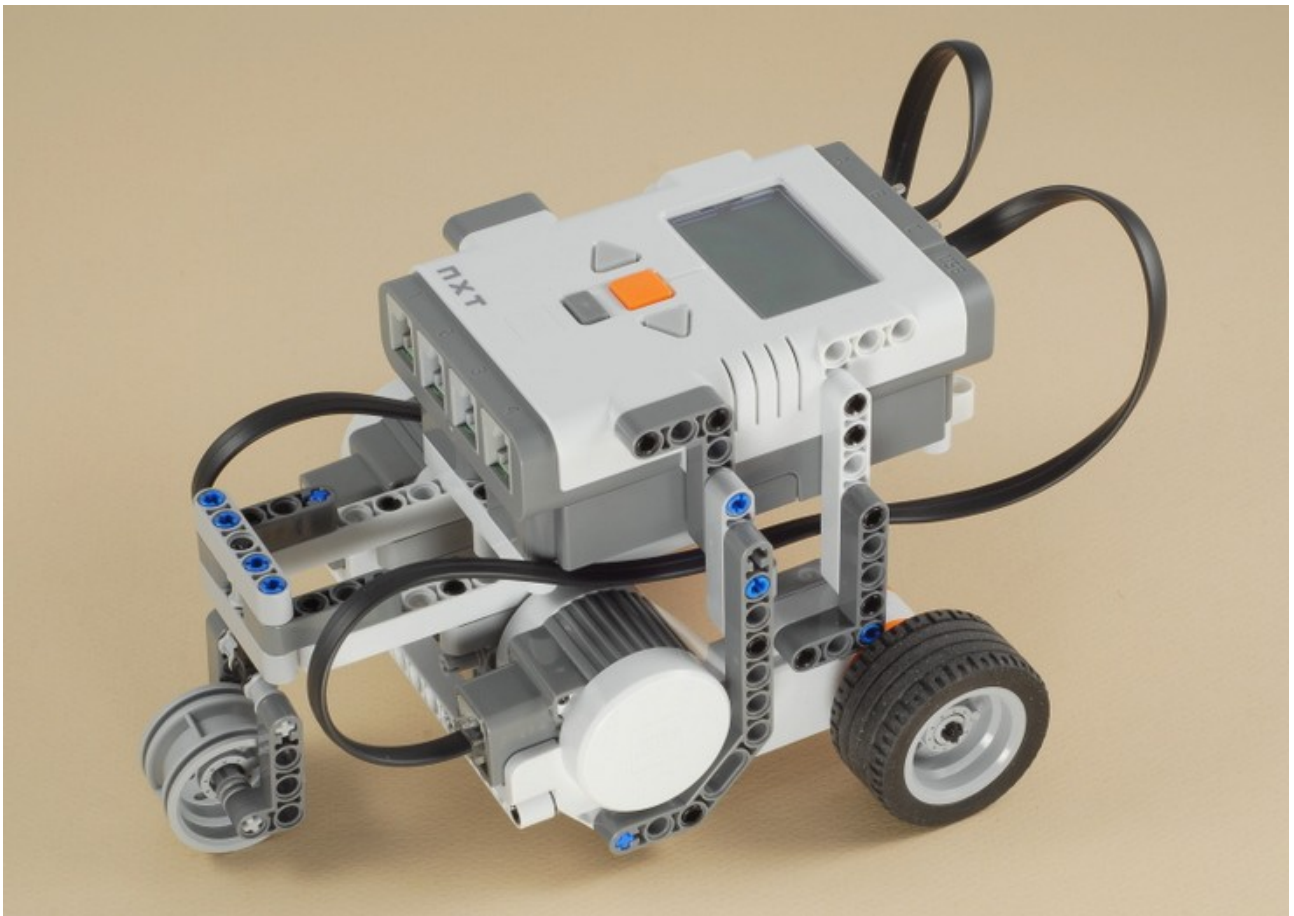

1.

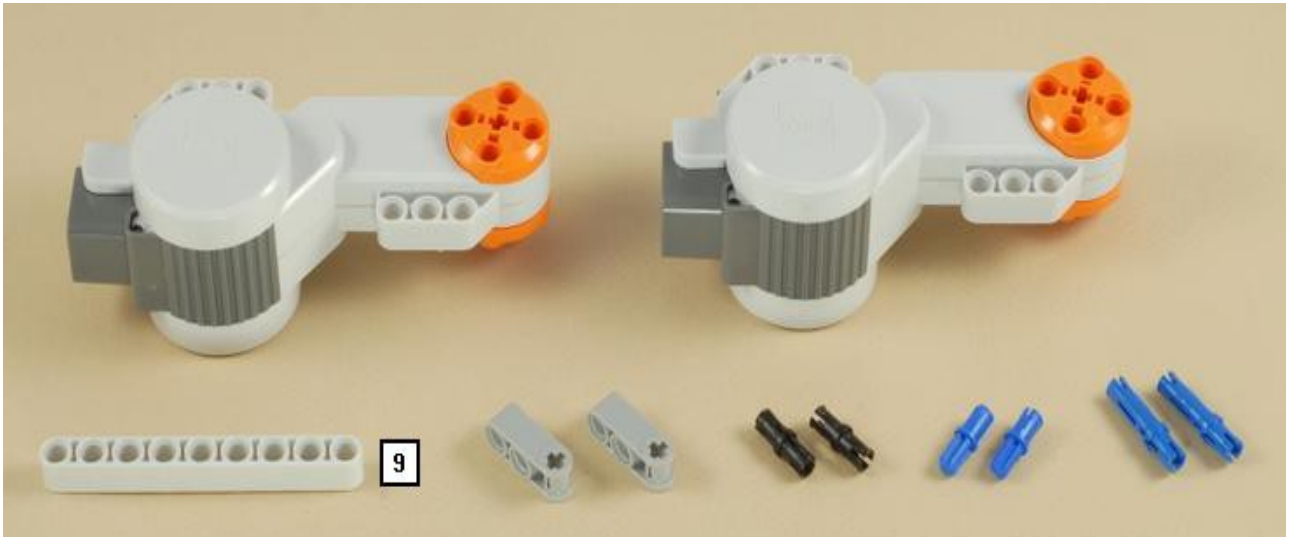

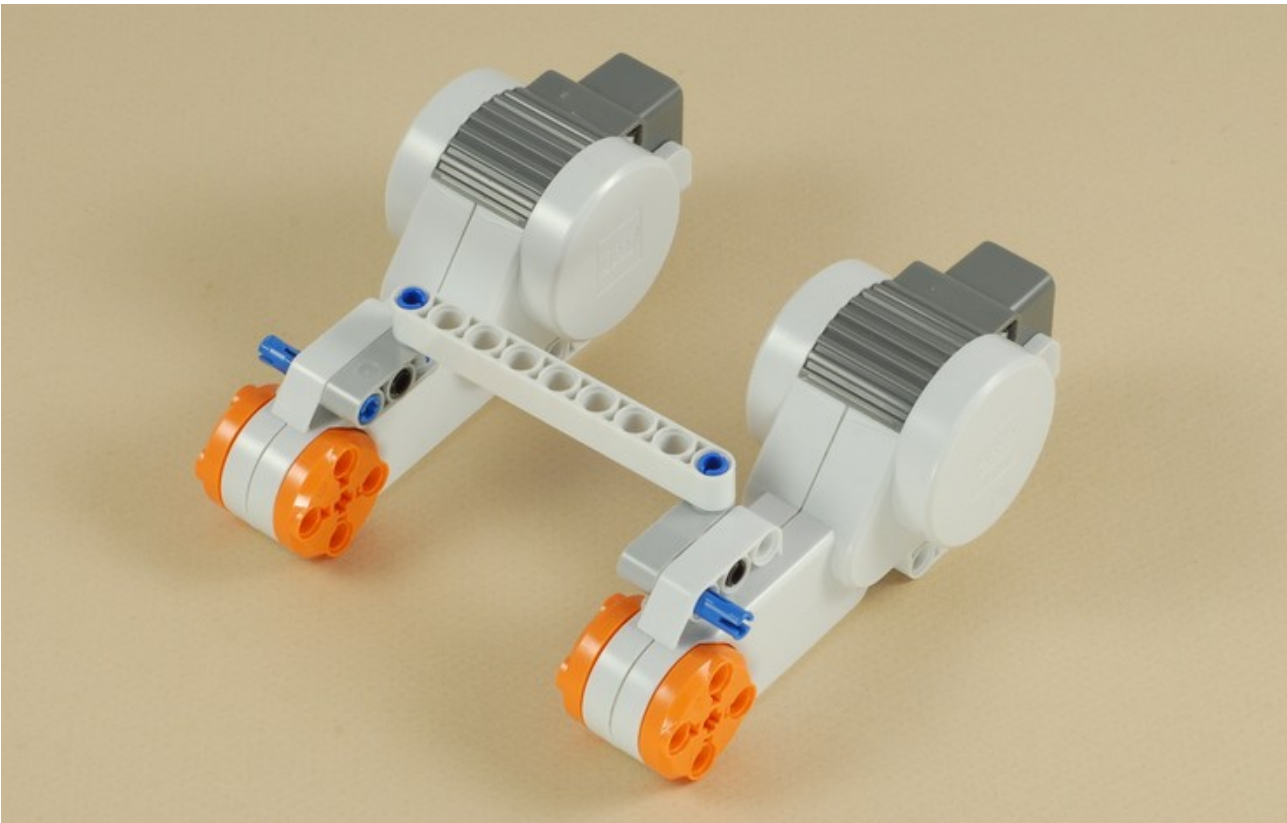
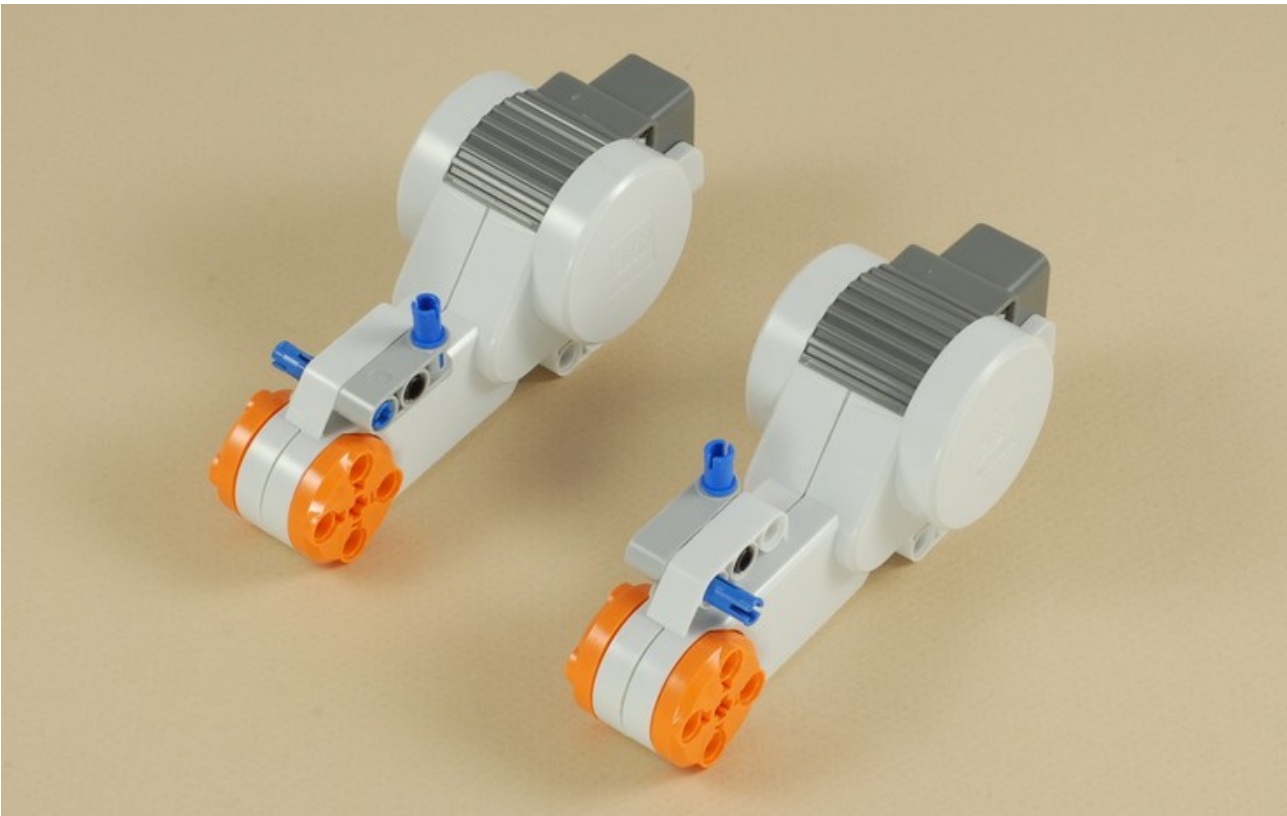

2.

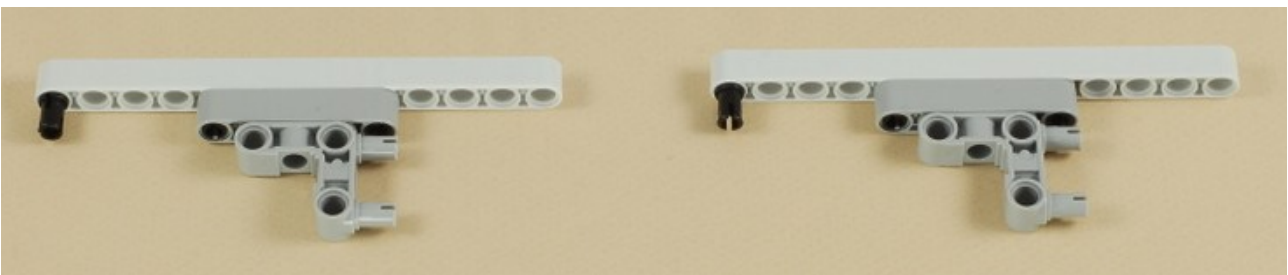
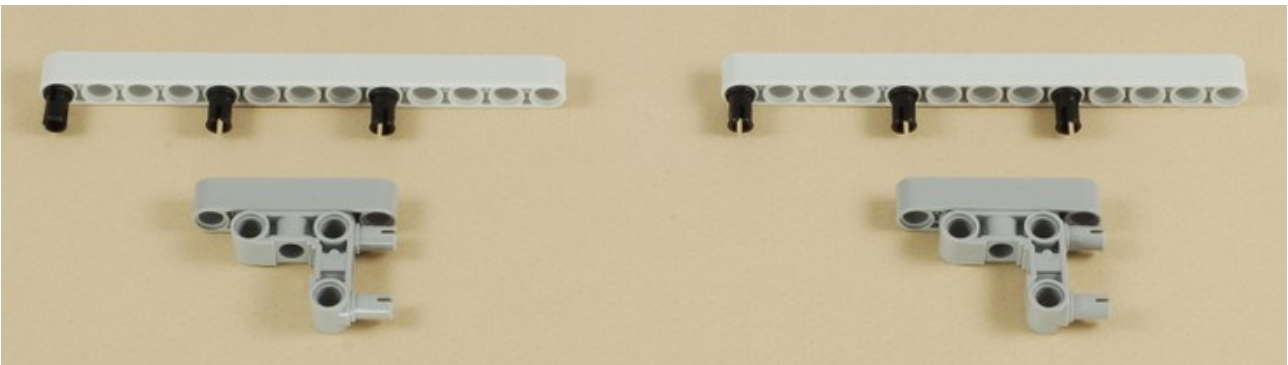
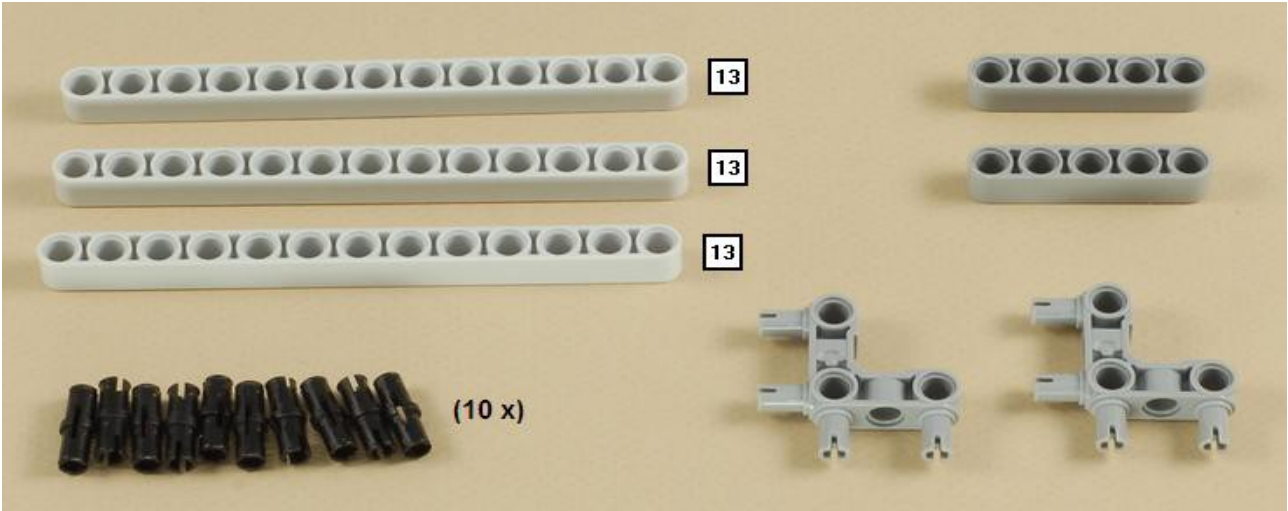

3.



3-AA



3-Li

3-AA (DLA BATERII AA)

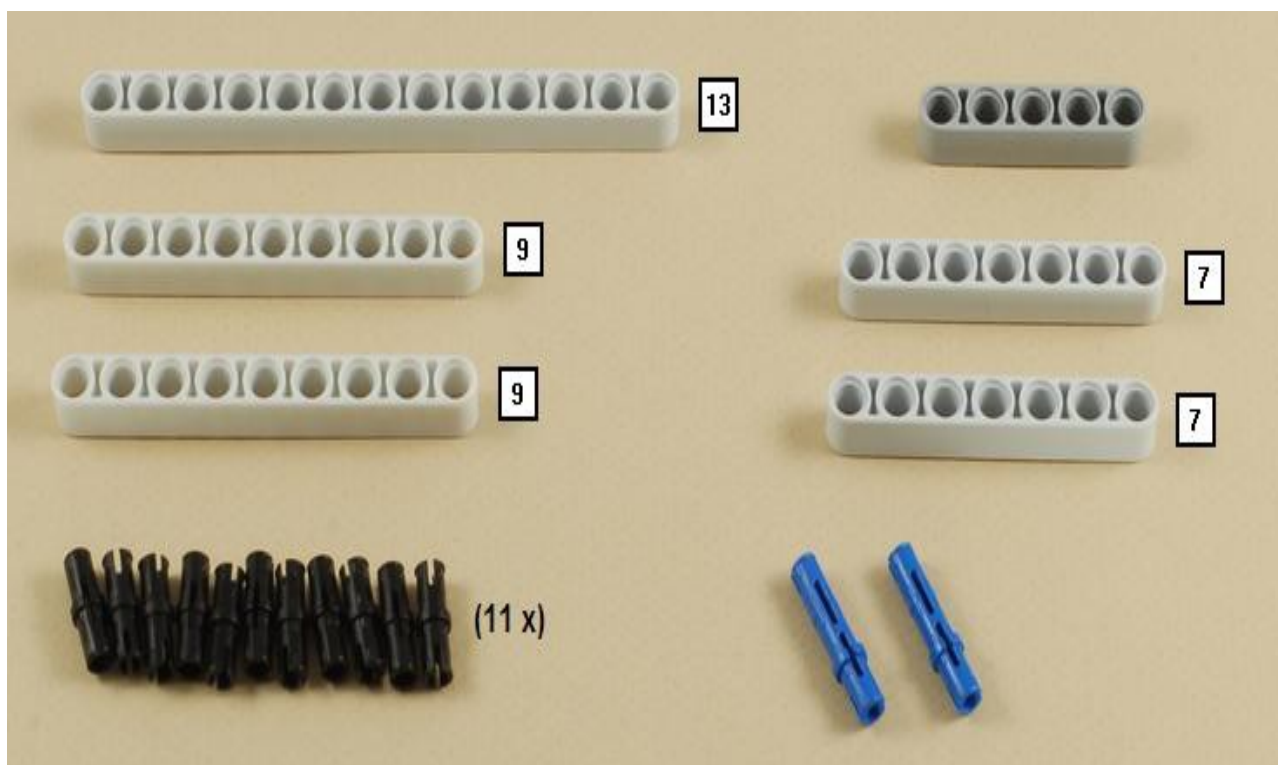

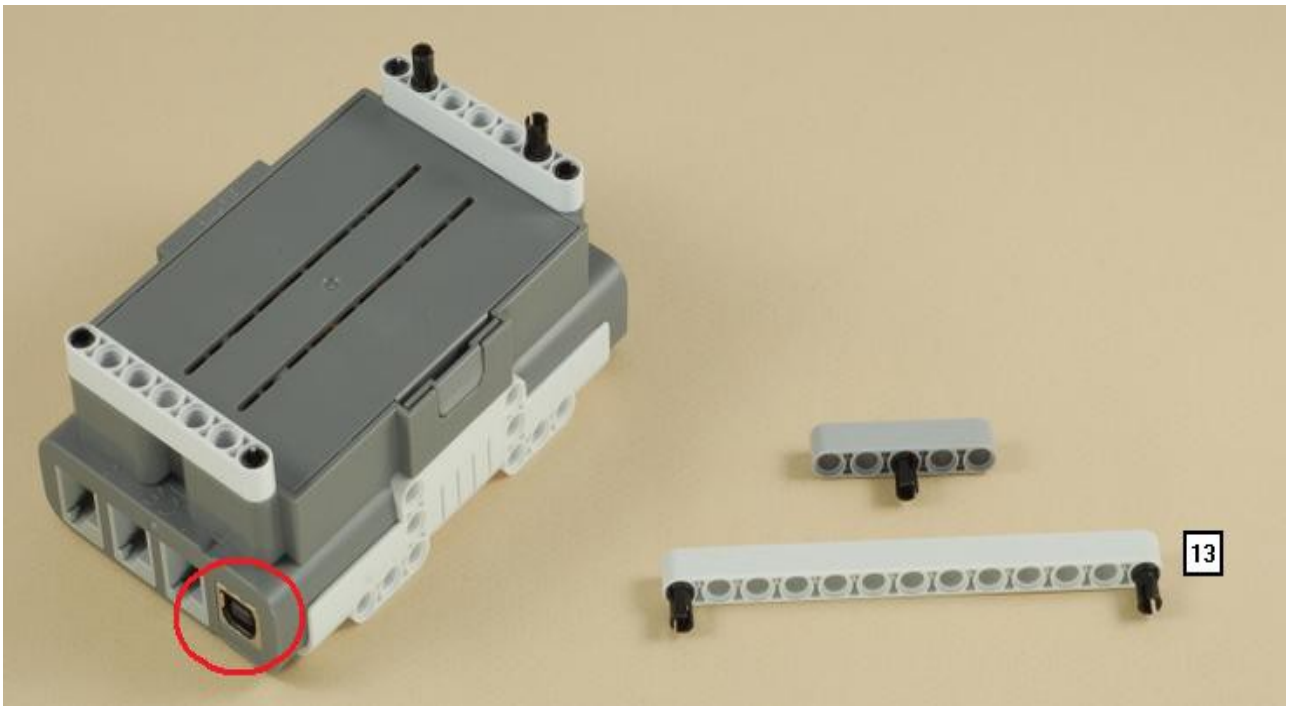
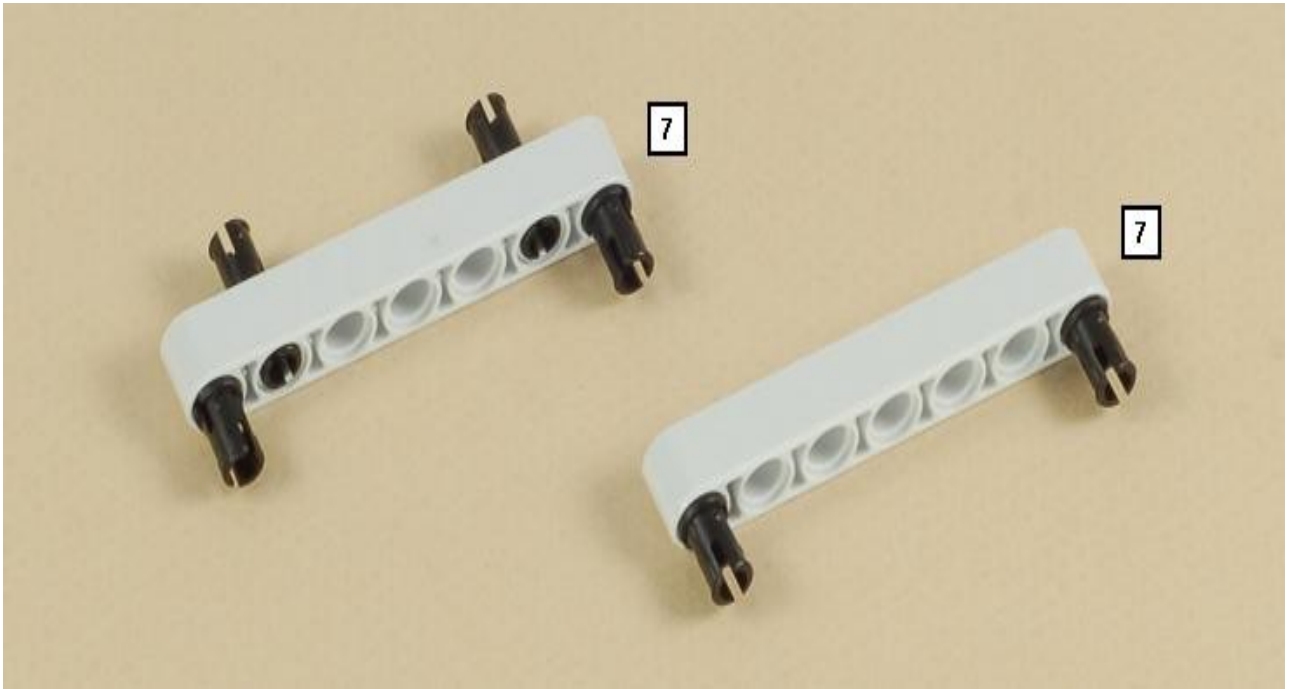

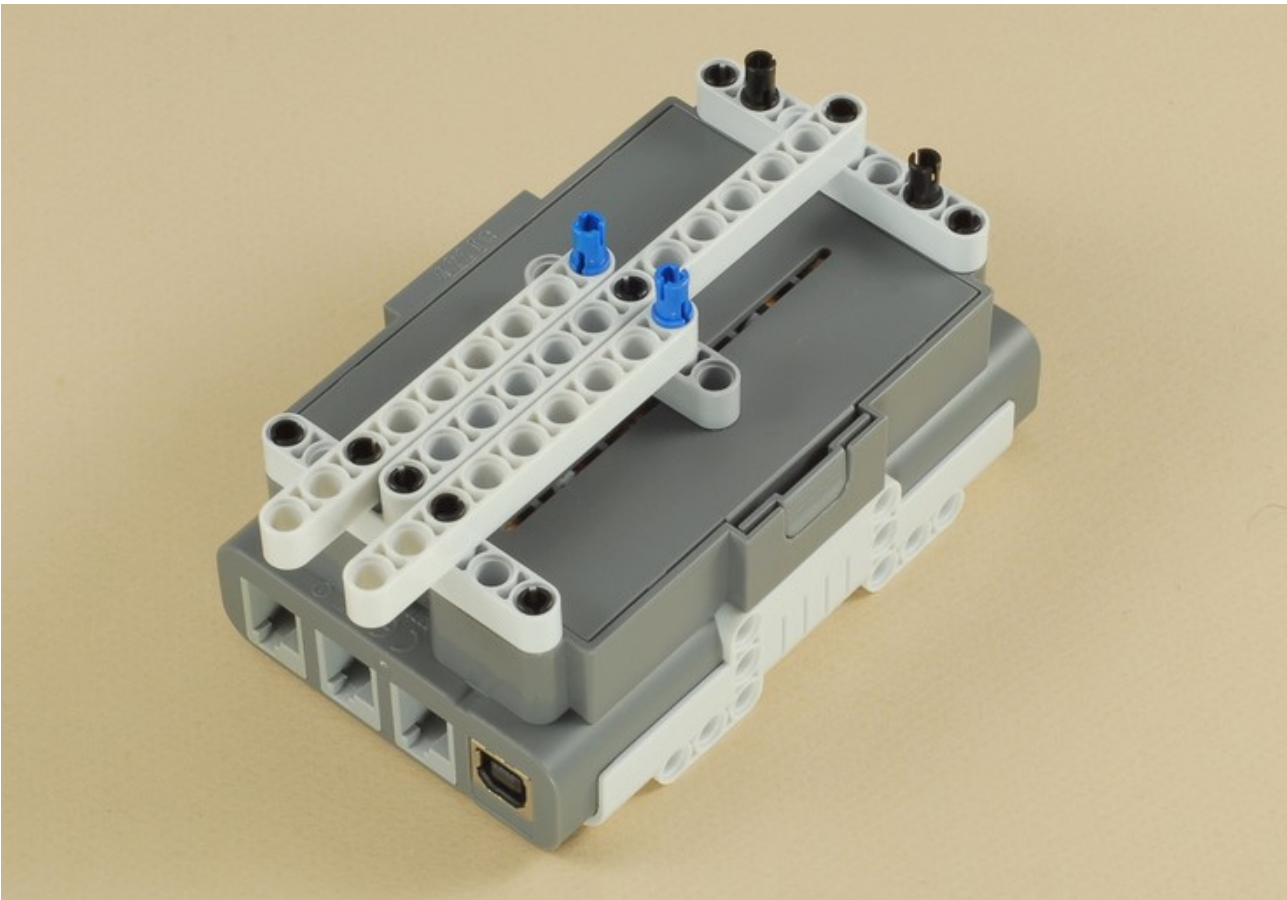
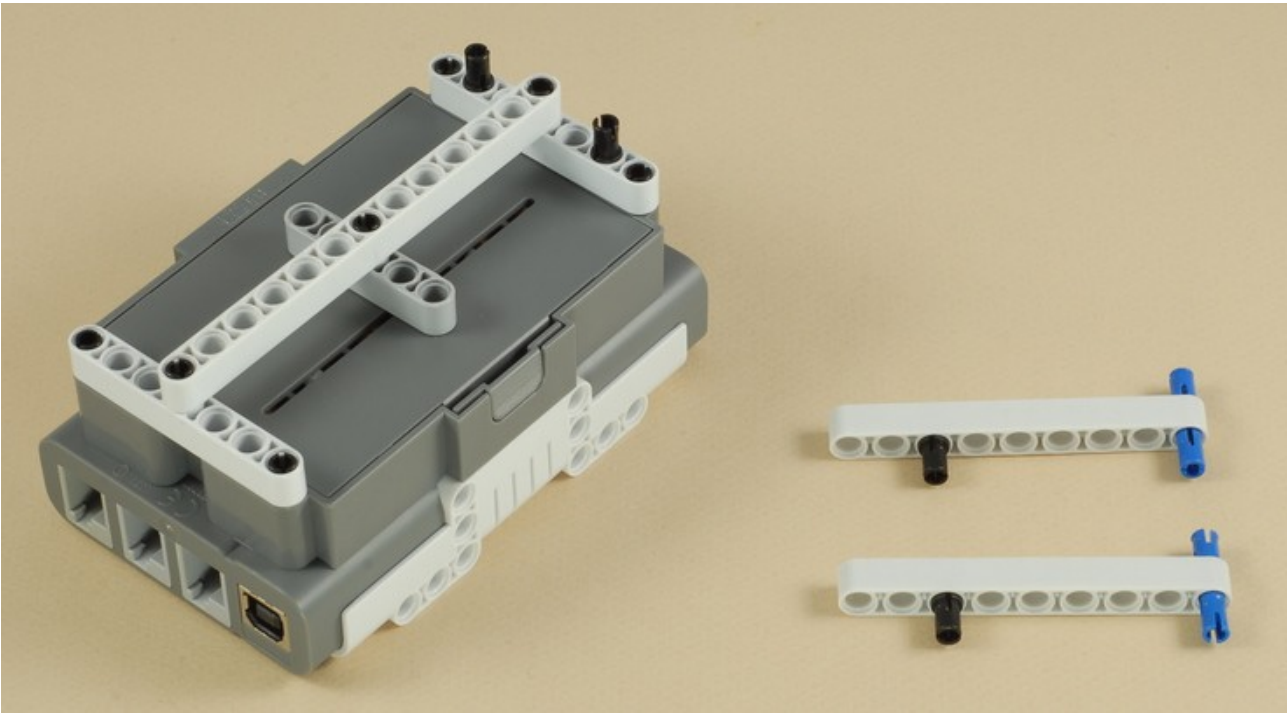

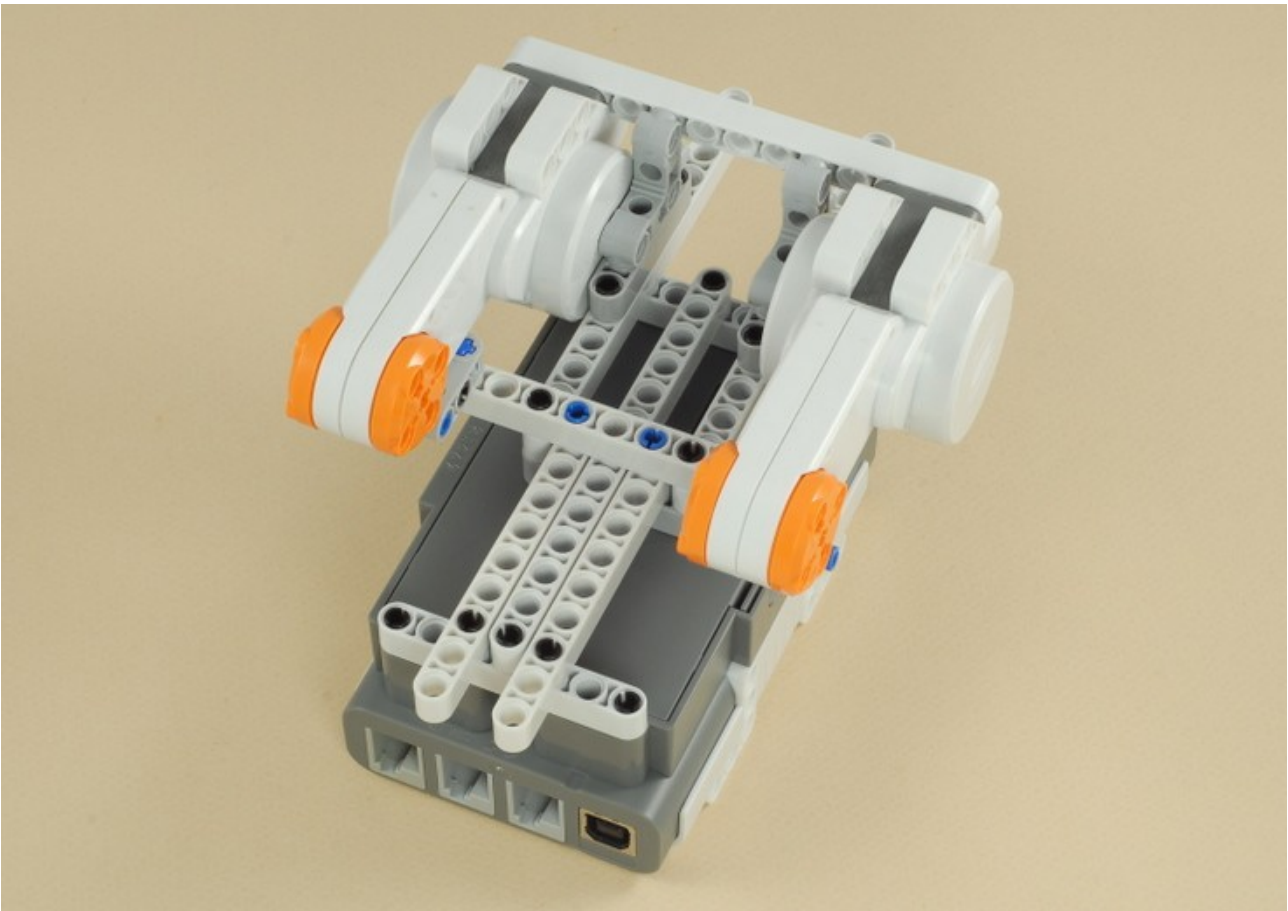

3-Li (DLA BATERII Li)

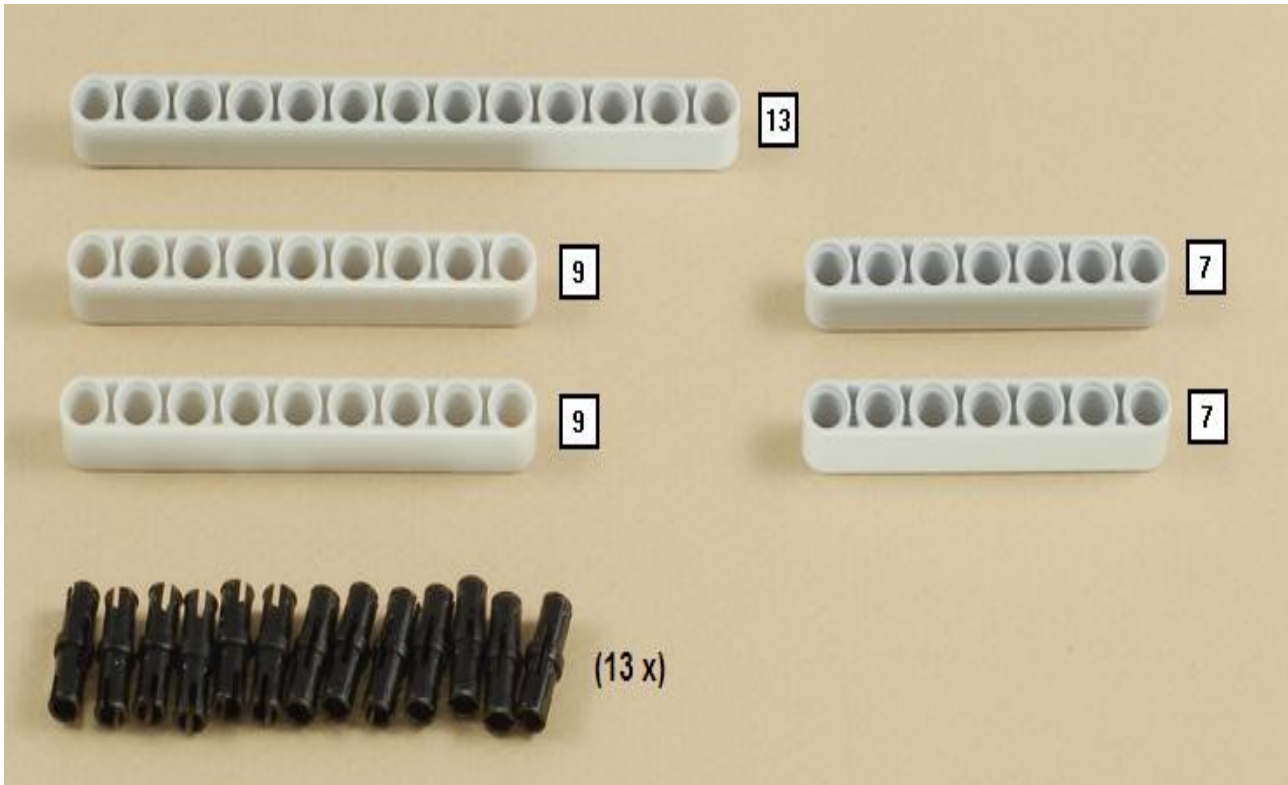

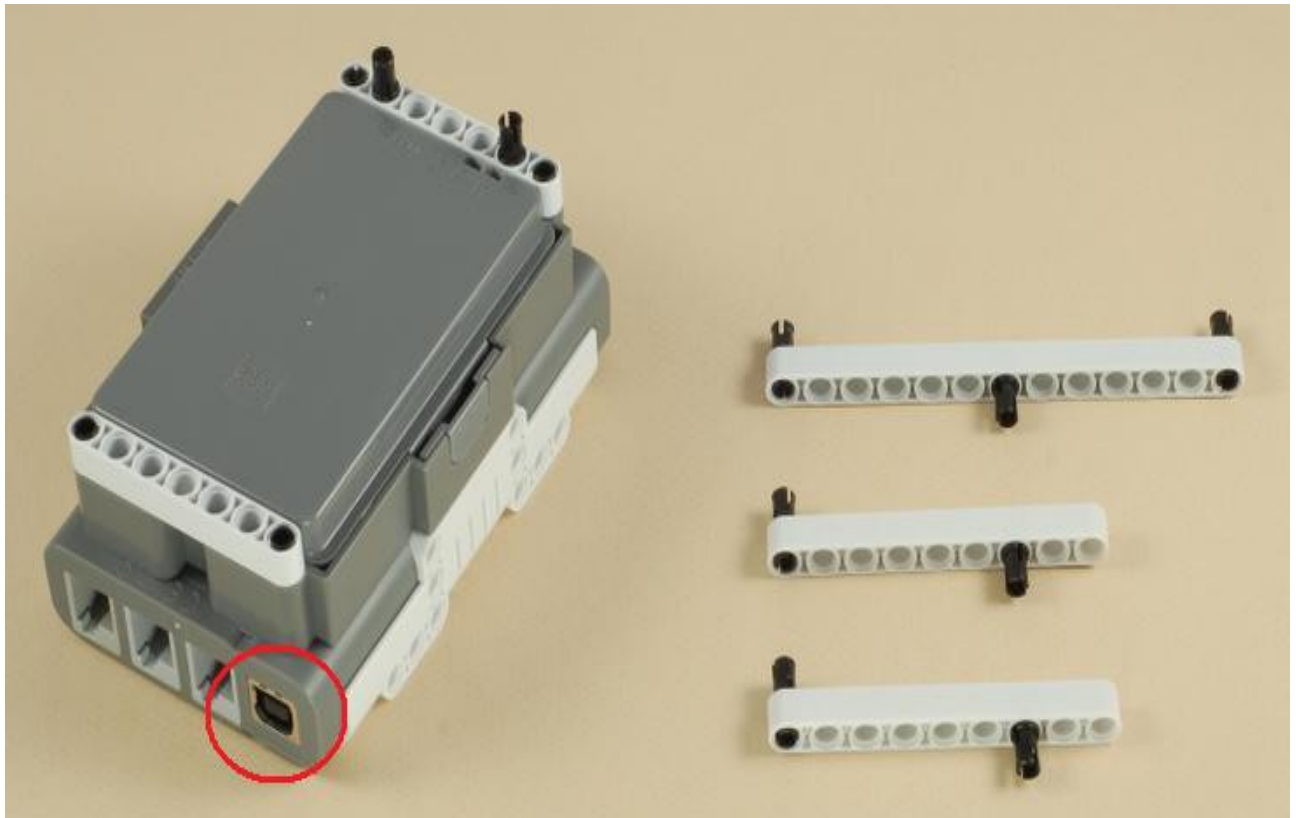
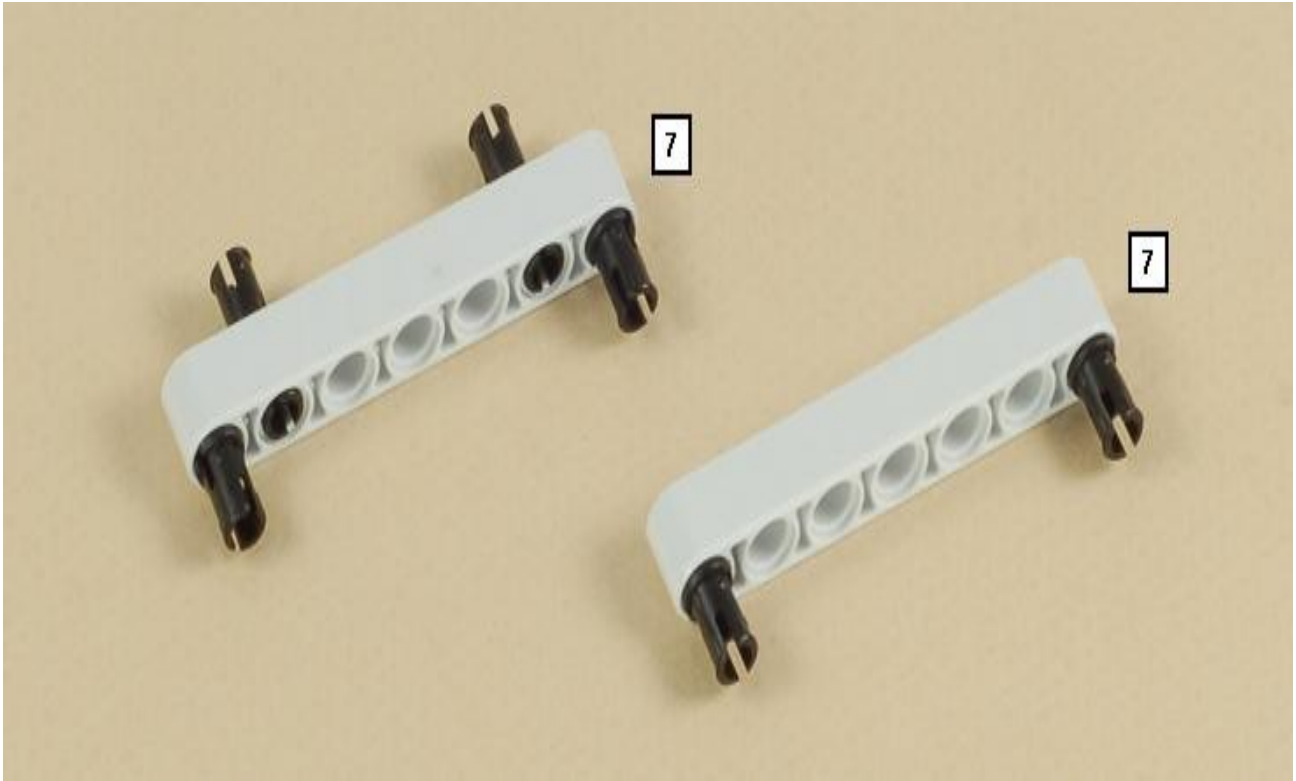

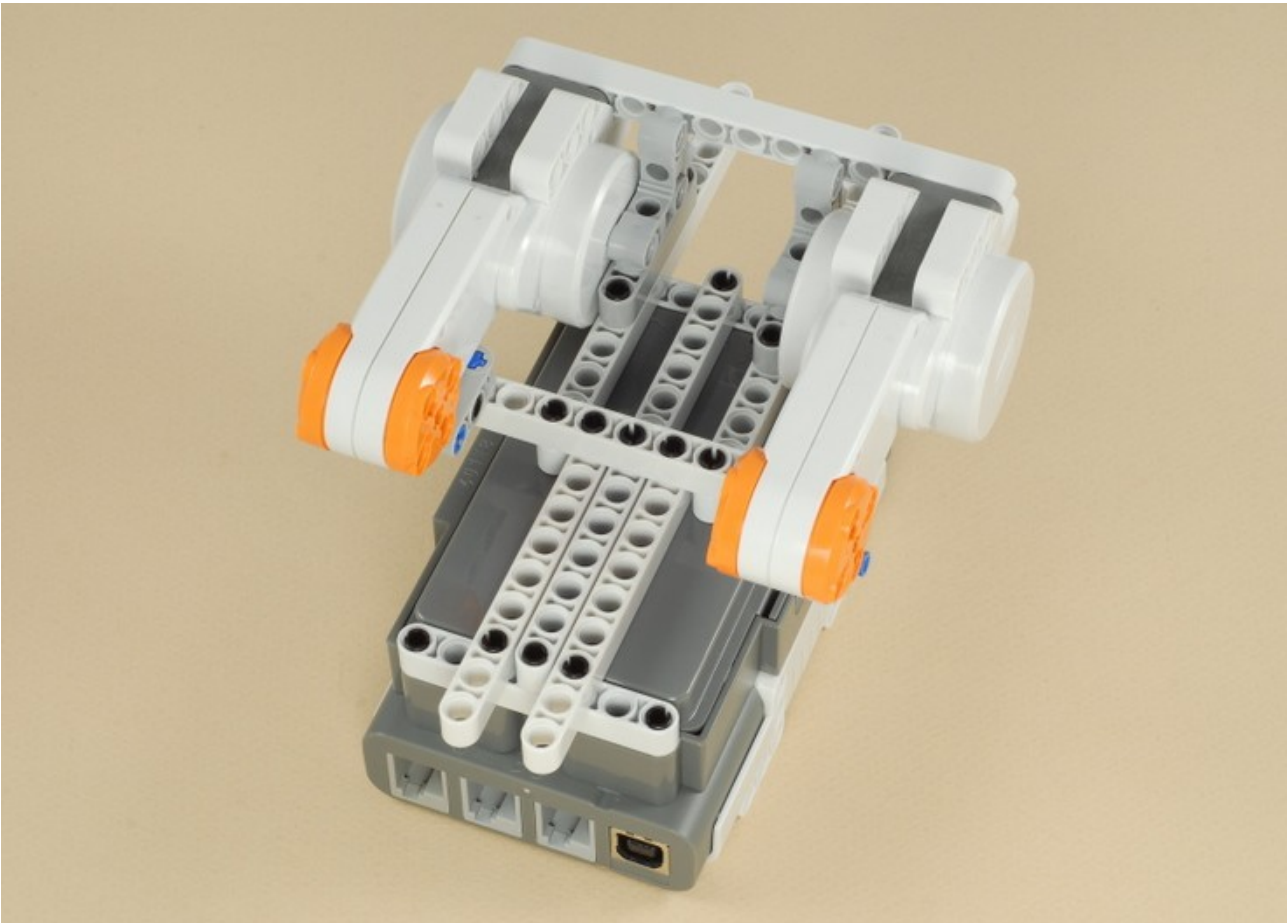
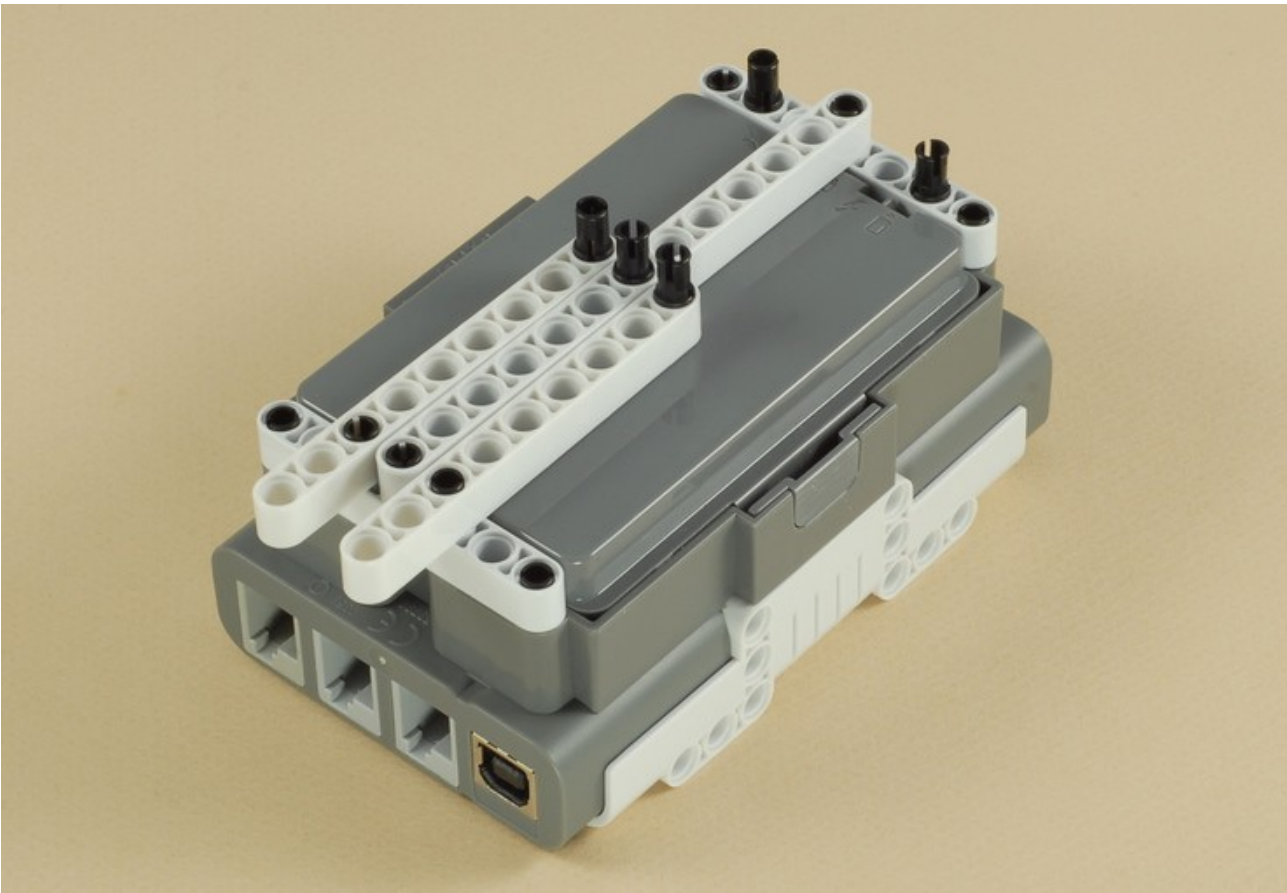

4.

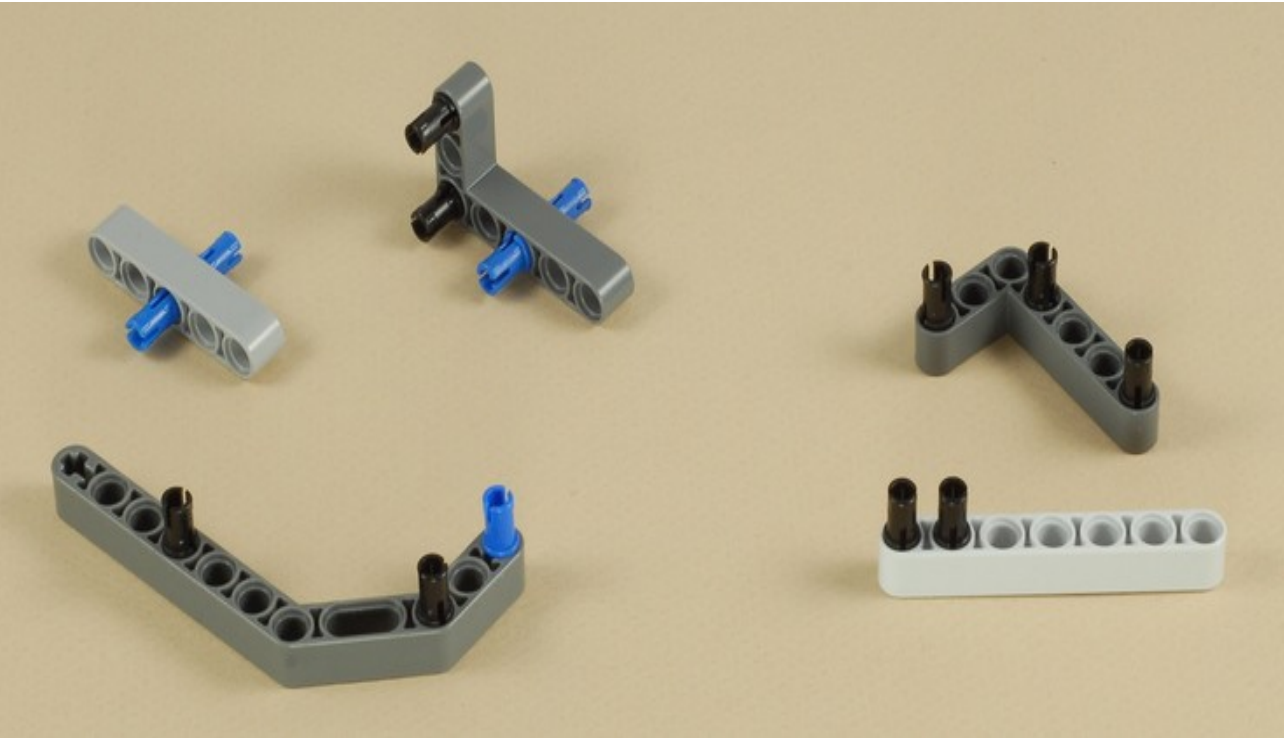
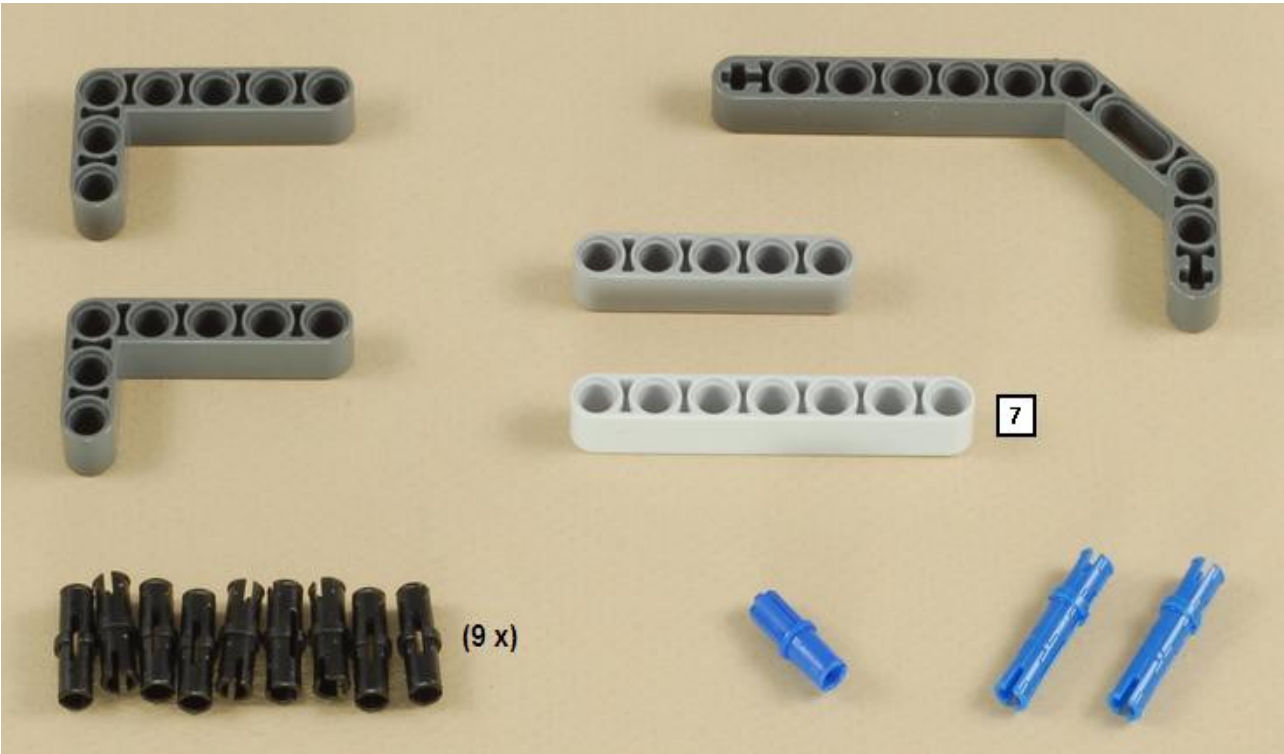

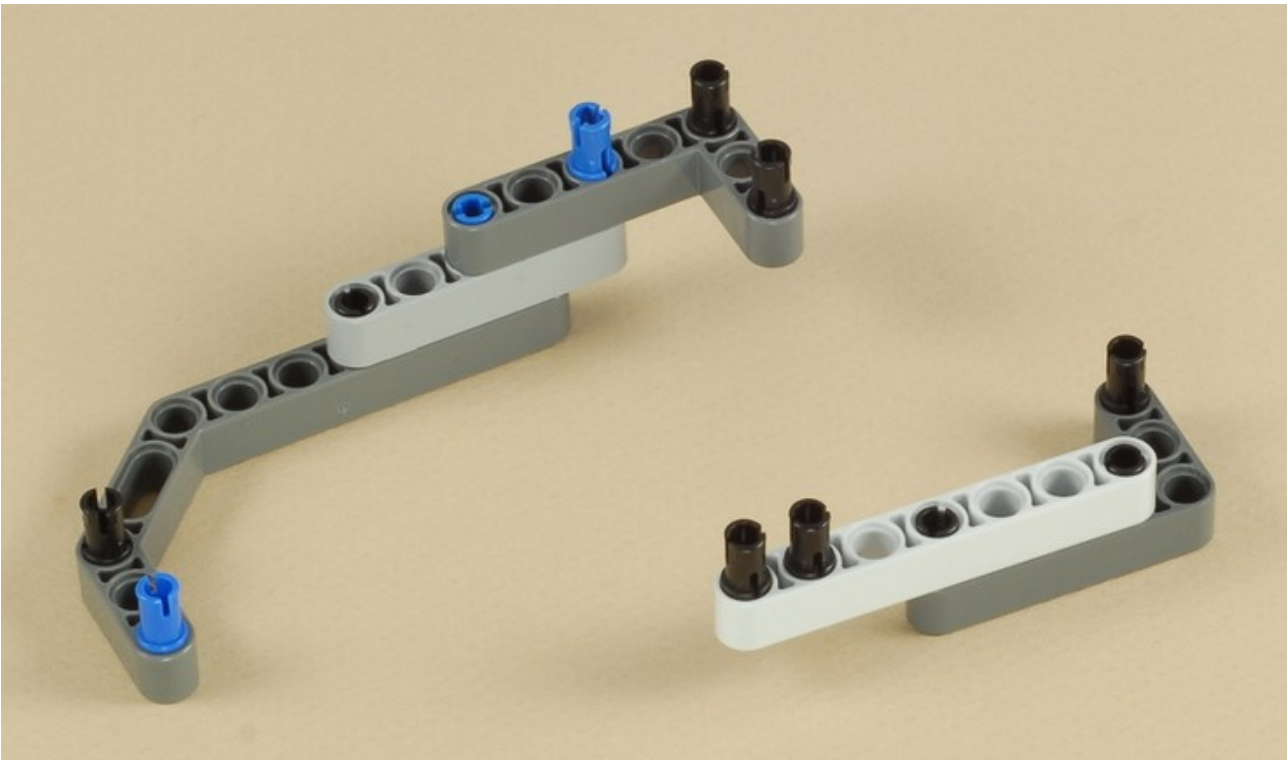

5.

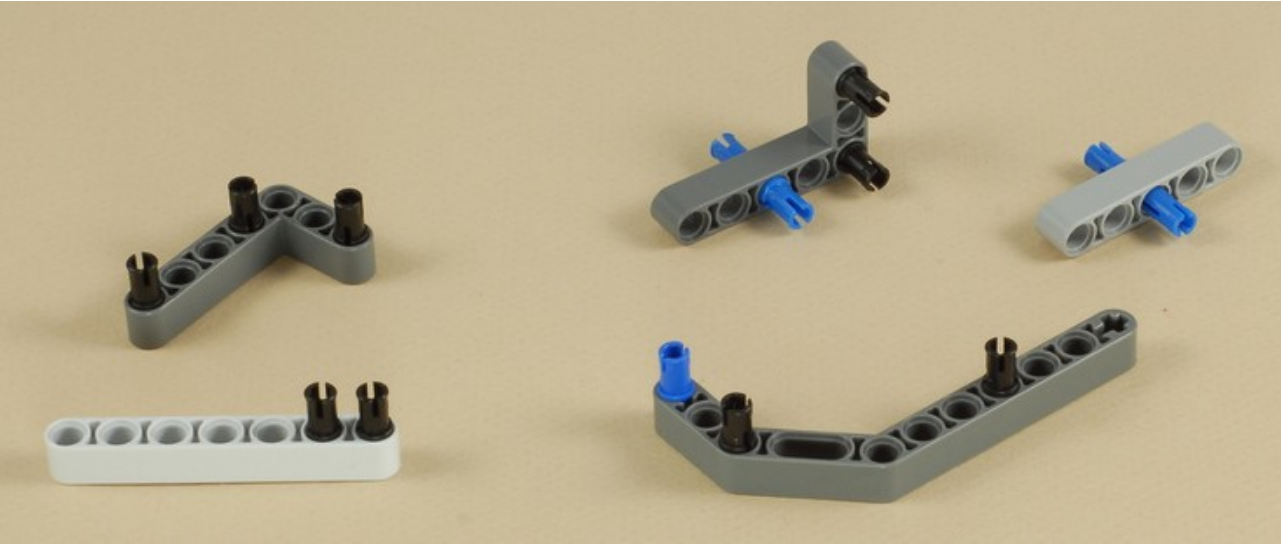
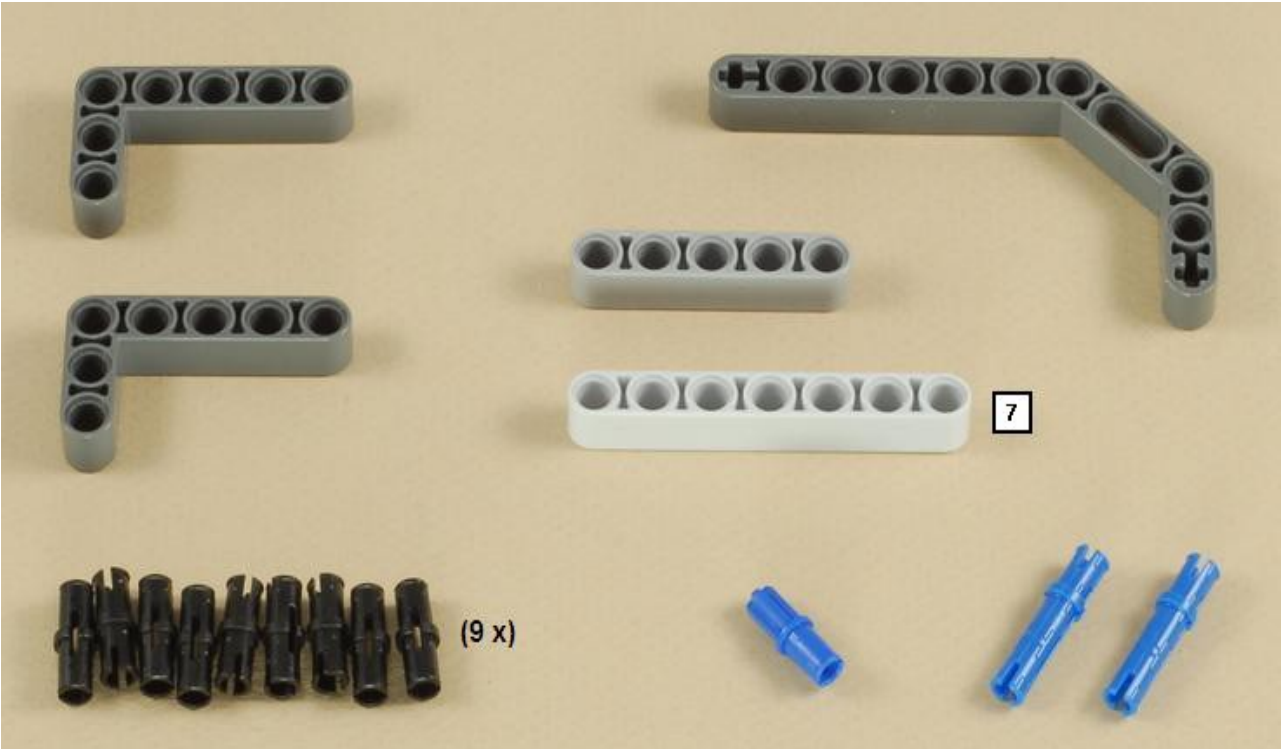

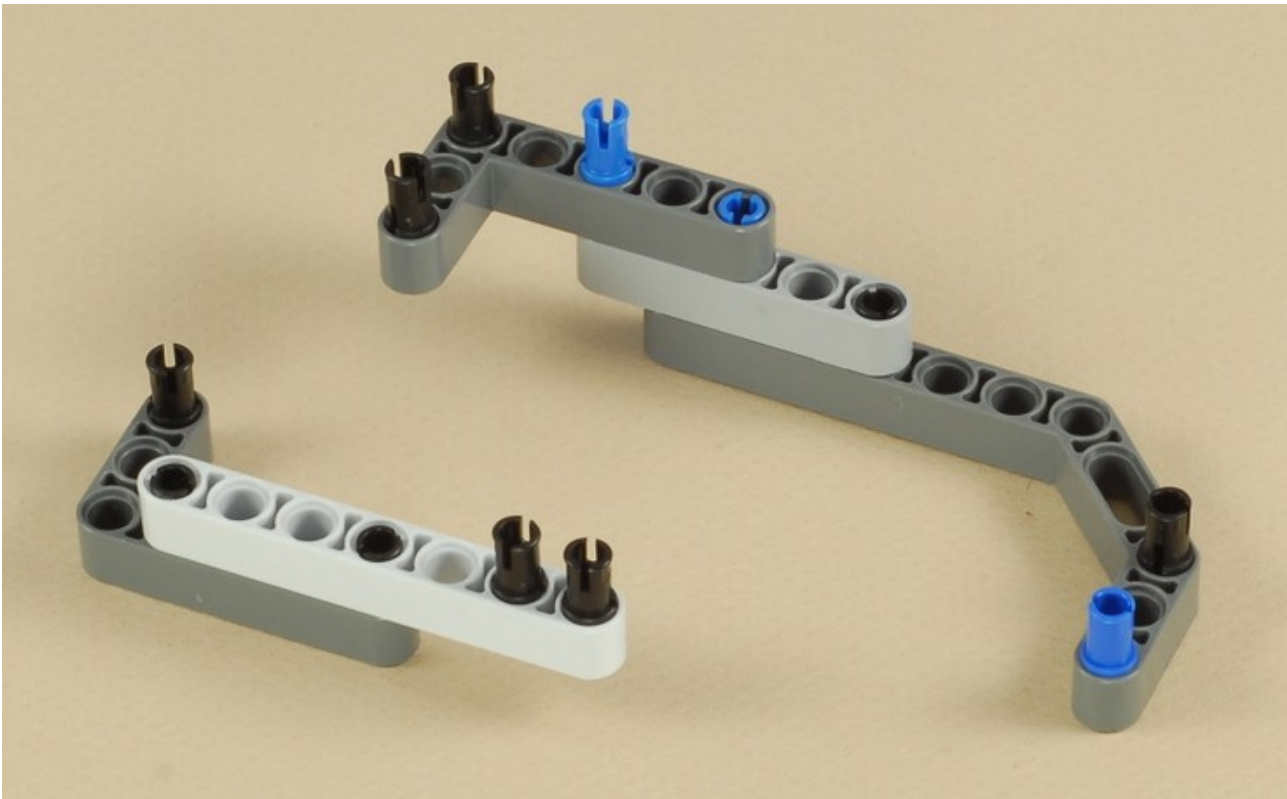

6.

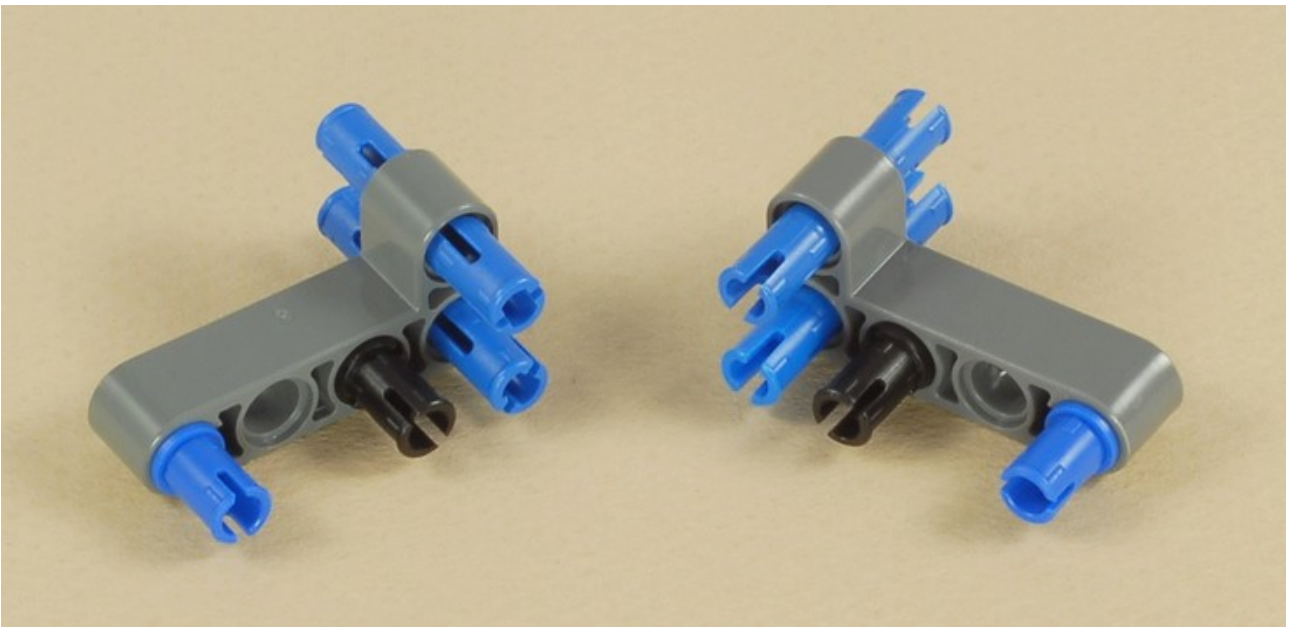
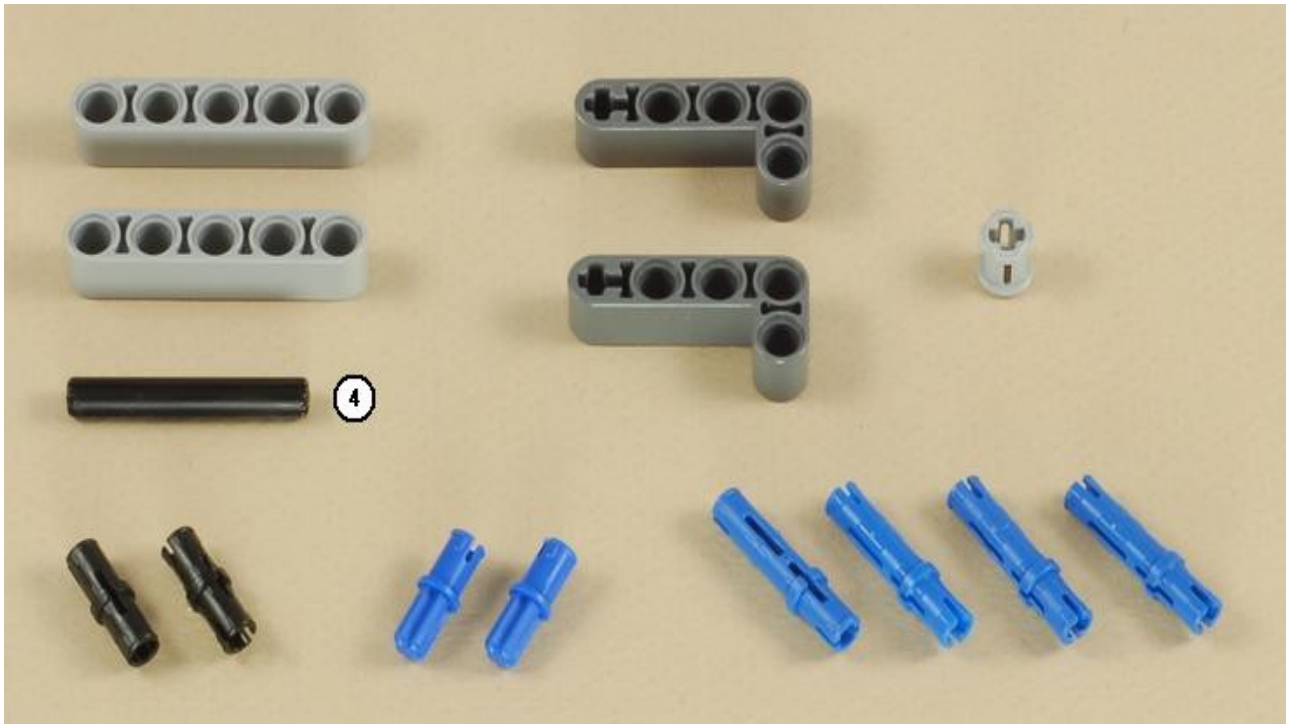

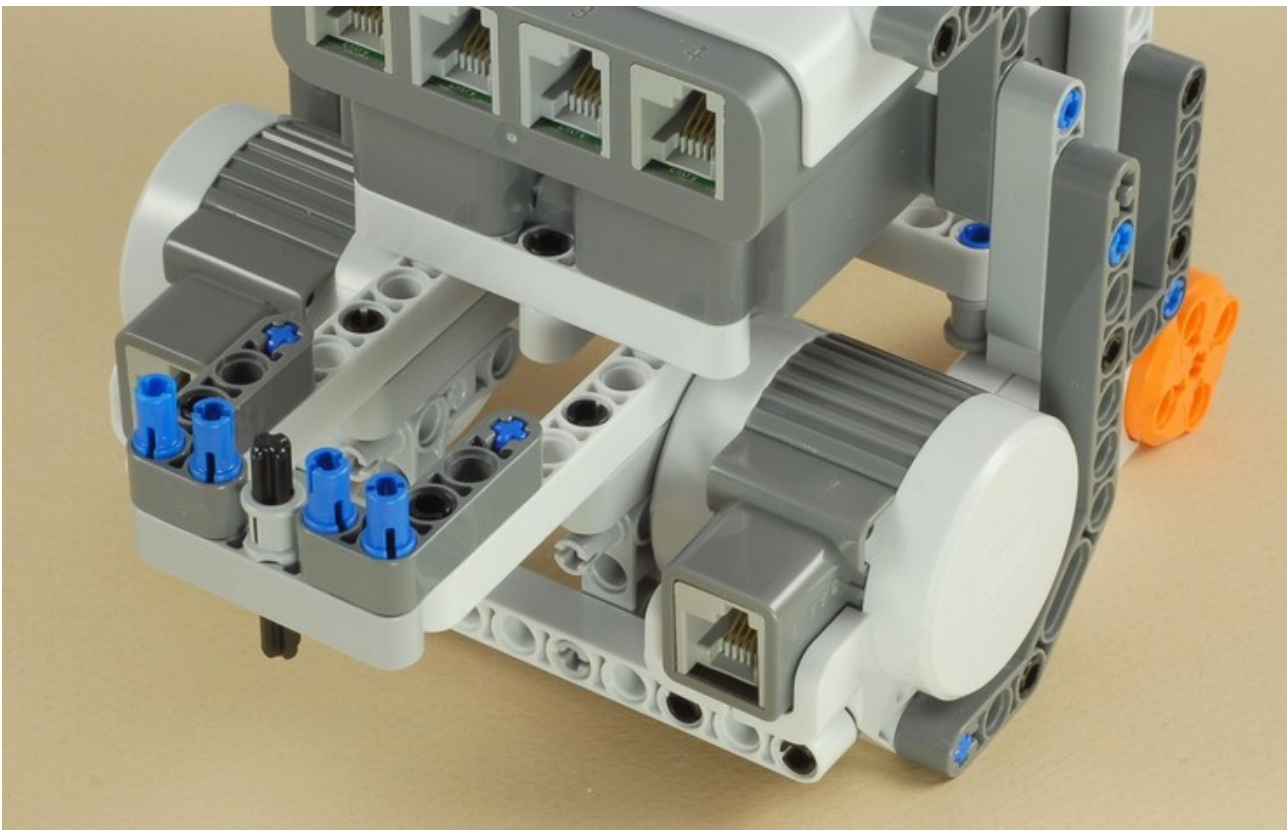
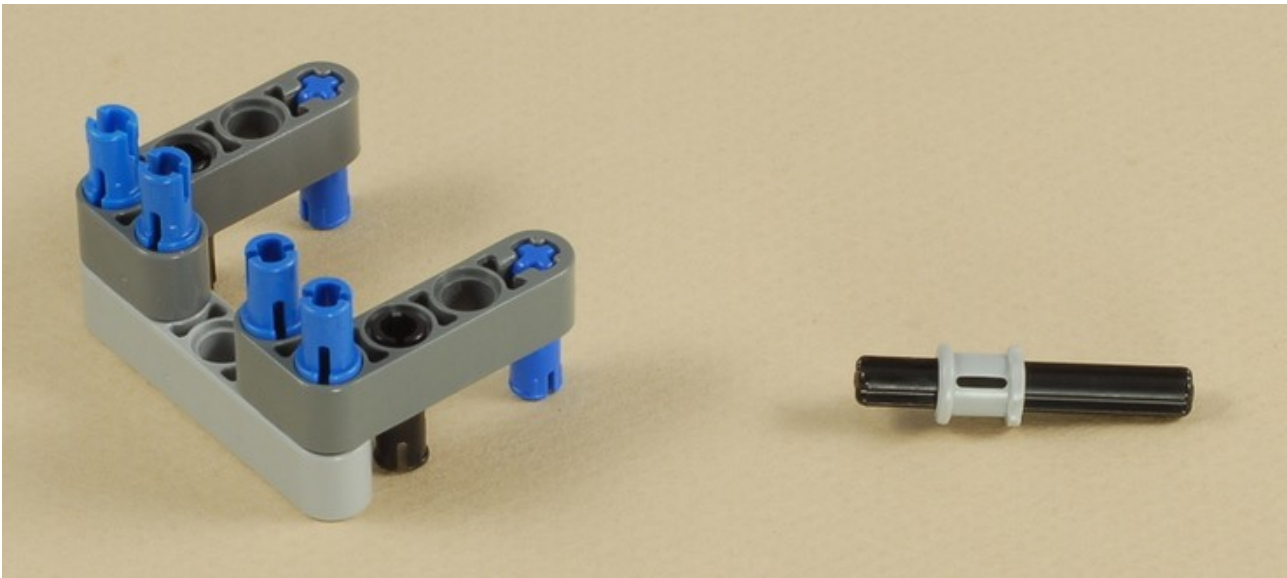

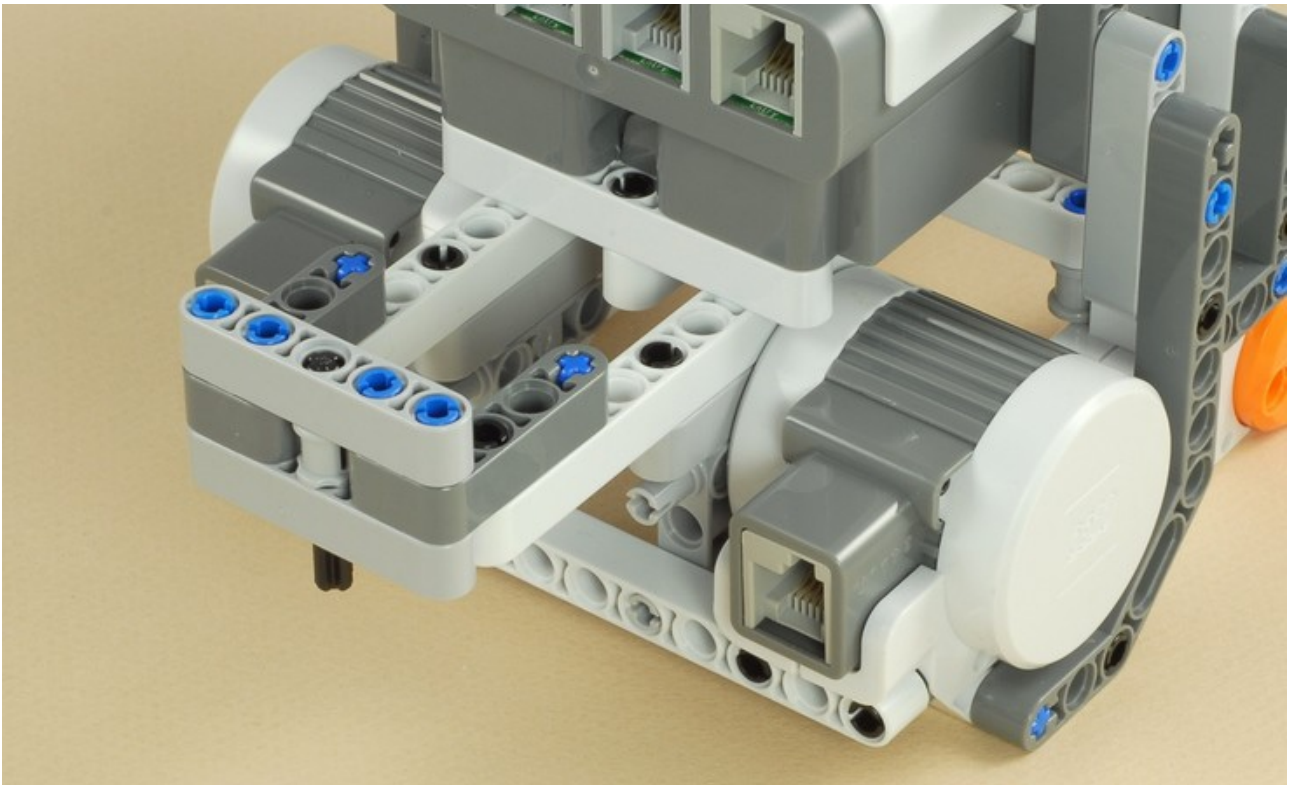

7.

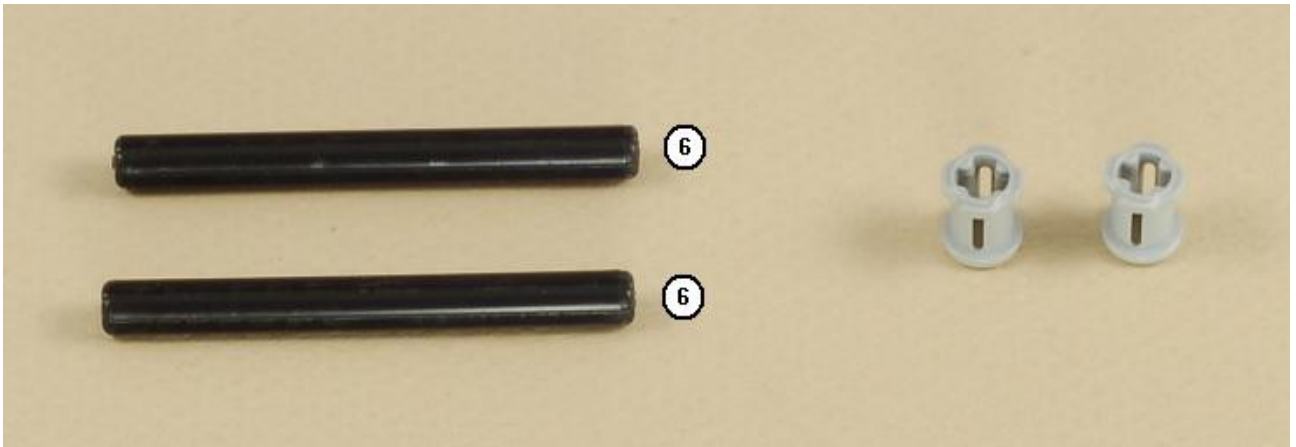



8.

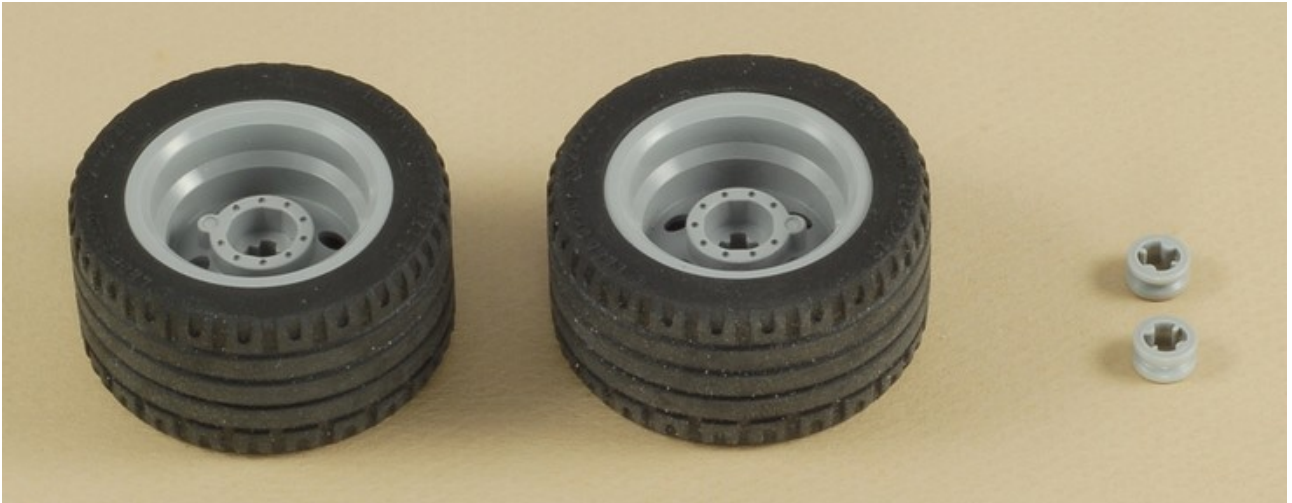

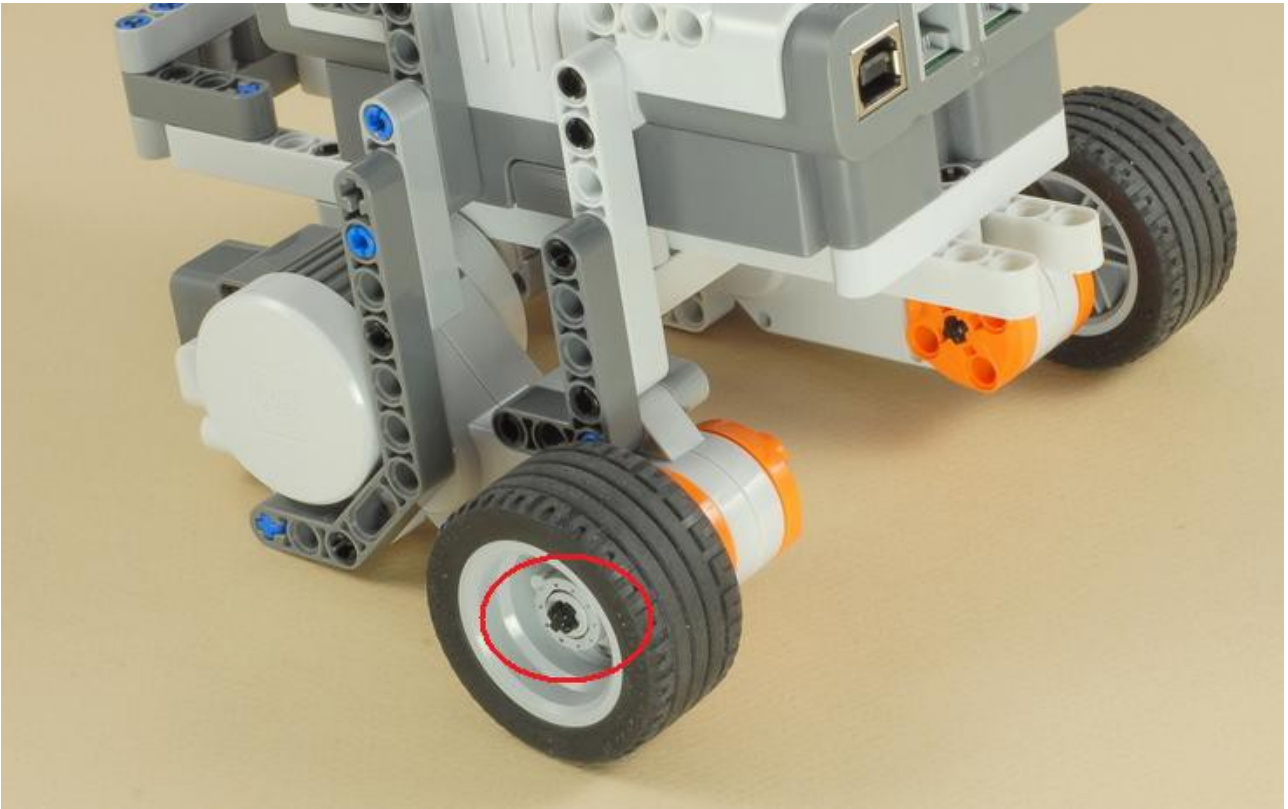

9.

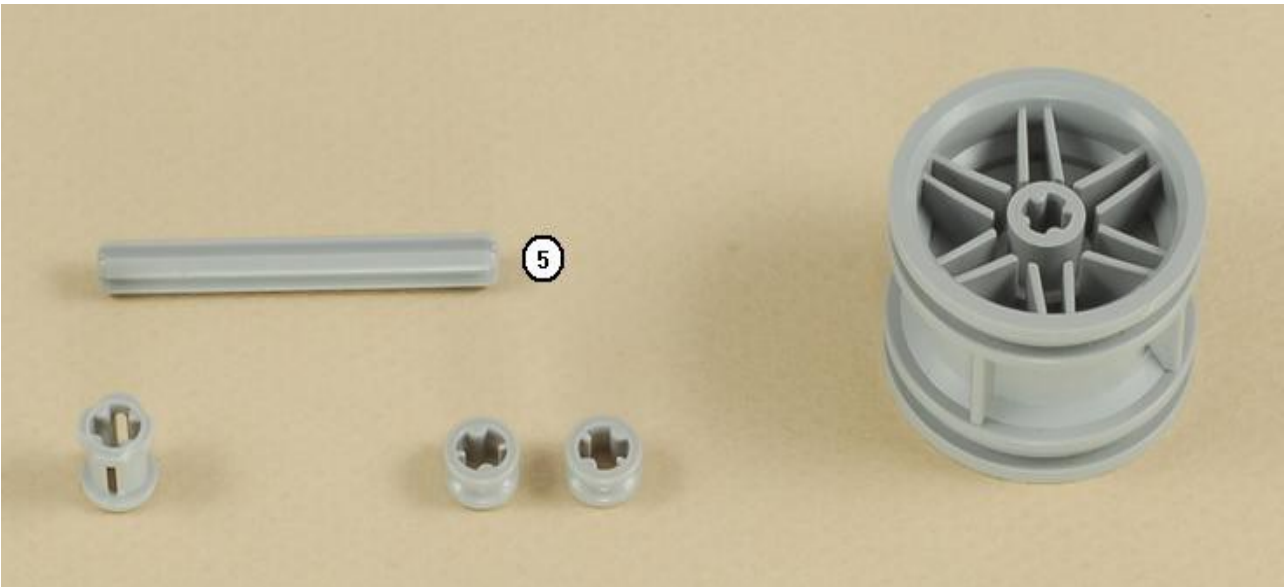

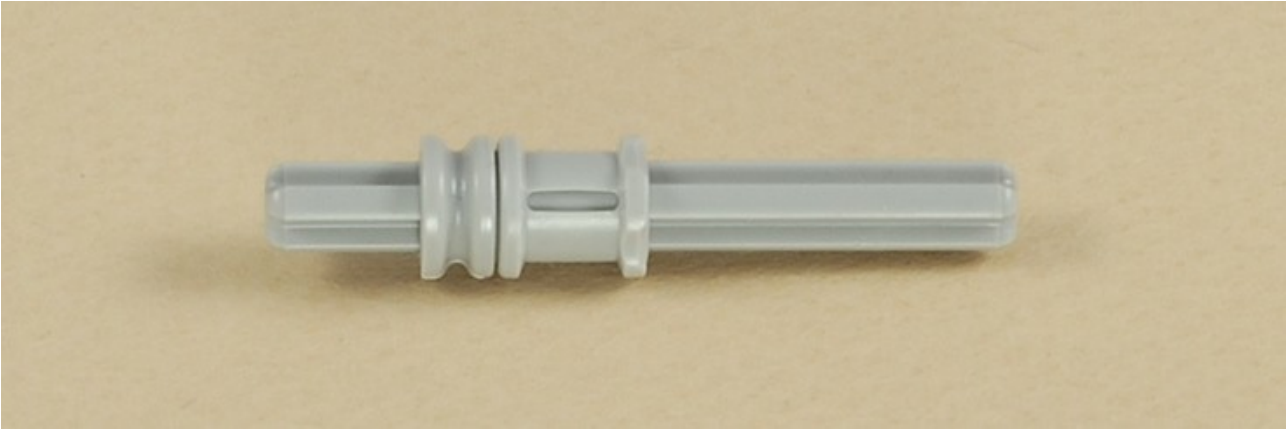



10.

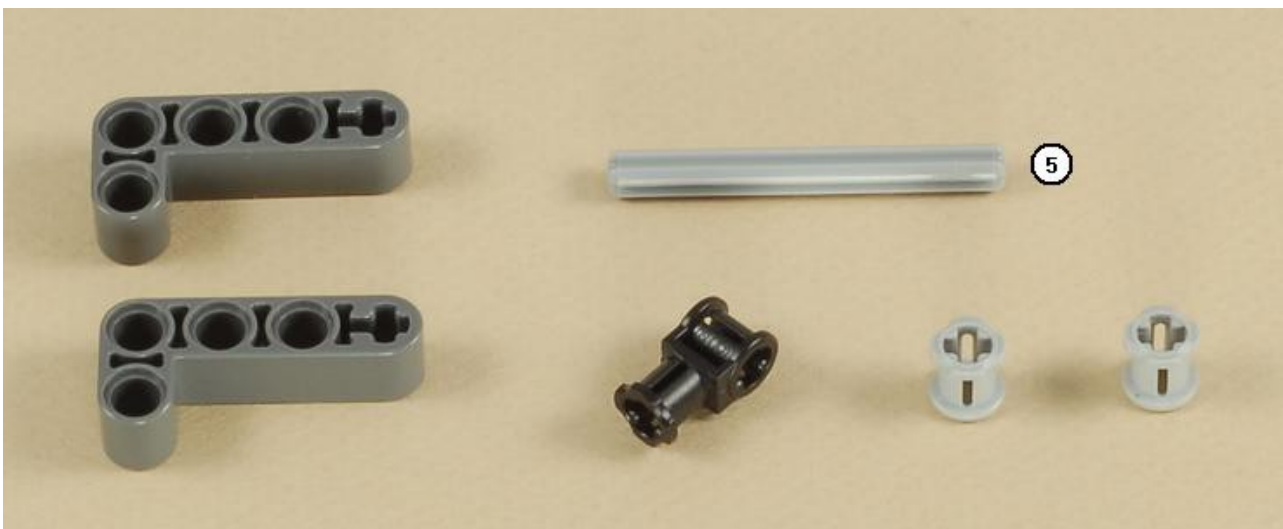

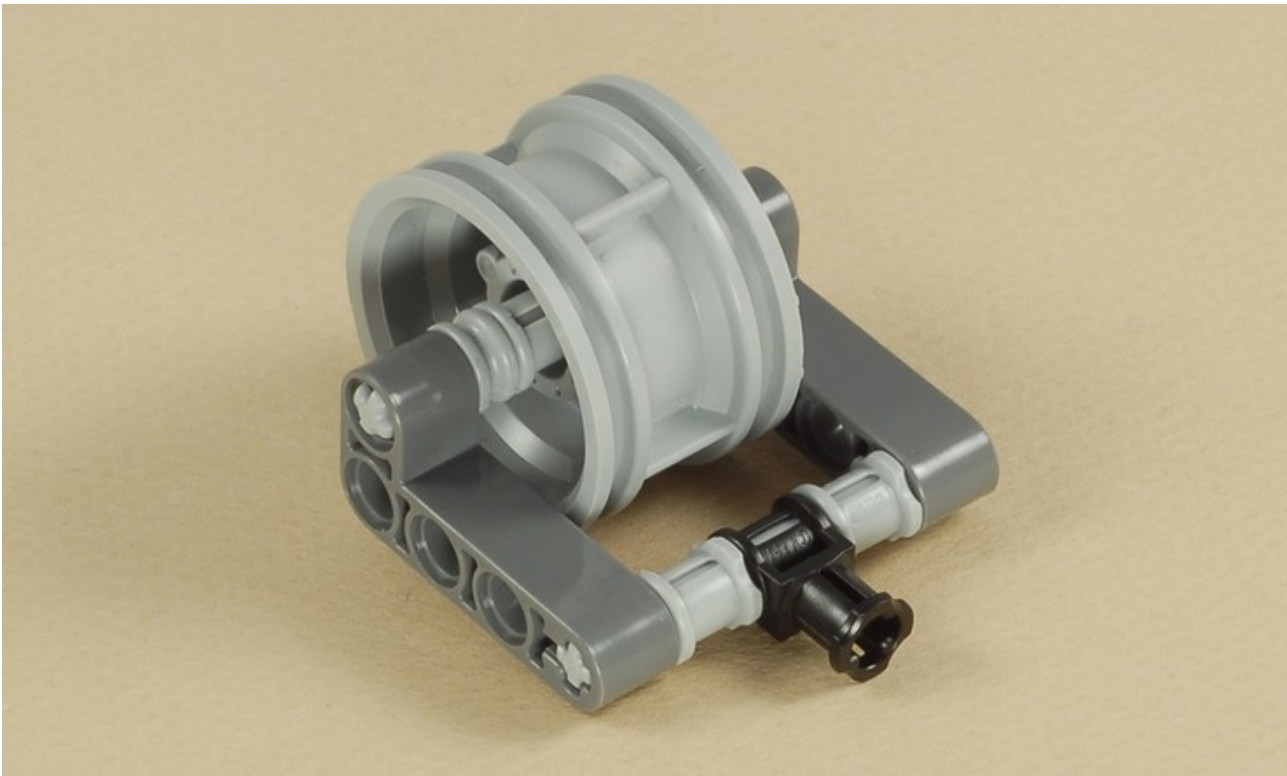

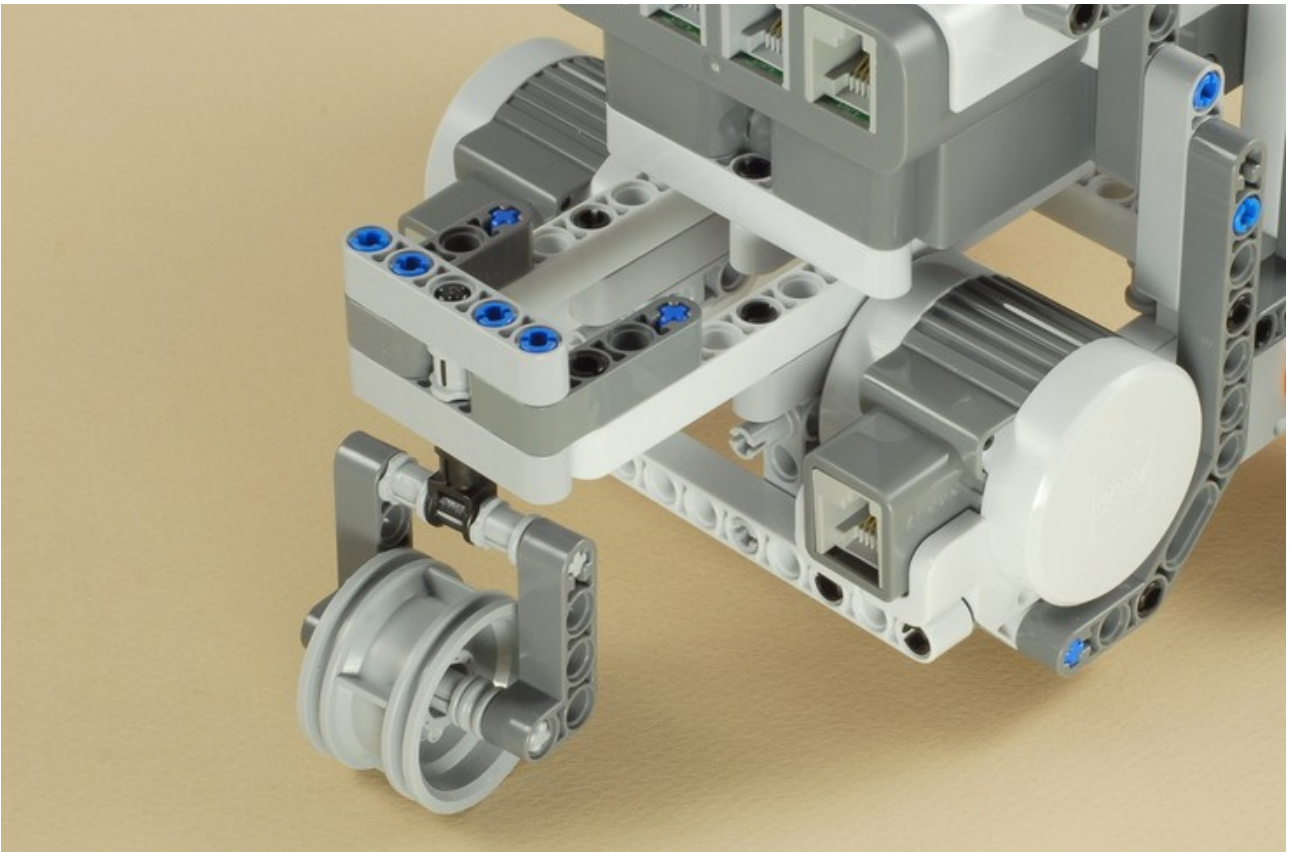

11.



